

*Protección Solar  
Pérgolas  
Sun Protection  
Canopies*



**nevaluz**<sup>®</sup>

*Soluciones a medidas para su negocio o vivienda  
Tailor-Made solutions for your home or business*

# Dakhla

## *Soluciones a medidas*

Las pérgolas son sistemas de protección solar que le permitirá disfrutar de la vida al aire libre en cualquier época del año. Con ella podrá ampliar su superficie habitable sin necesidad de realizar obra en cualquier ubicación, sean cuales sean sus características.



## *Tailor-Made Solutions*

Canopies enable you to enjoy living outdoor at any time of the year. They enable you to increase the living surface anywhere, without the necessity of realizing construction works. Canopies are ideal, whatever your projects are.



## ***Mecanizado de piezas de aluminio***

Nuestro nuevo proceso de fabricación es revolucionario en el sector de la Protección Solar. El proceso de mecanizado CNC garantiza un resistencia y mejor acabado que con los procesos convencionales de fundición.

## ***CNC machining of aluminium parts***

Our new CNC manufacturing process is a revolution on the sun protection market. The accessories result to be more heavy-duty and with a better finish than with other manufacturing processes (such as drop forge or injection).

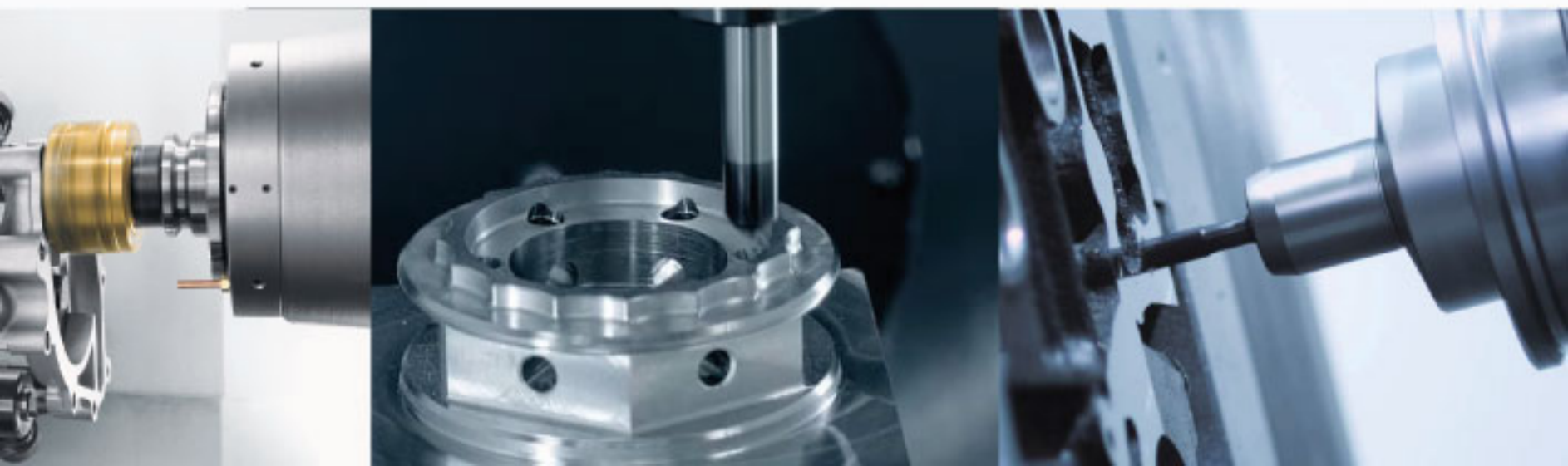

“ La pérgola regulará de forma natural la temperatura de su estancia, al tiempo que le protegerá de la radiación solar, lluvia, viento, o cualquier otra inclemencia meteorológica.”

“ Canopies naturally regulate the ambient temperature while they protect you from UV, rain, wind or any further weather inclemency. ”

*Sistema de drenaje  
Drainage System*

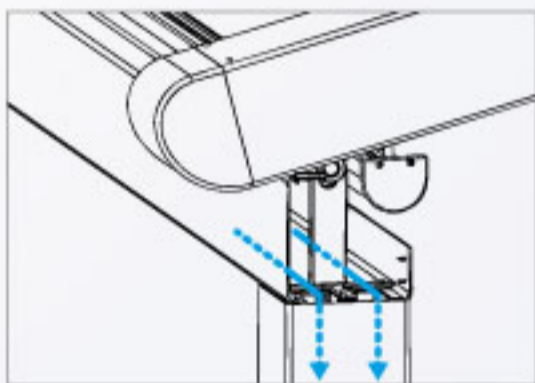

*Iluminación leds  
Led Lighting*



*Gran variedad de acabados  
Many finish possibilities*



*Sistema propio de motorizado  
Own motorization system*

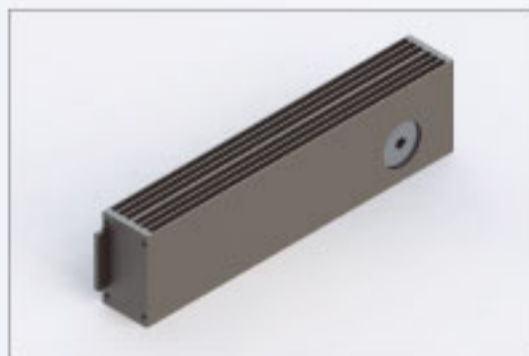

## Soluciones

Nuevas soluciones para cada tipo de ventana. Gracias a nuestra nueva tecnología podemos diseñar o fabricar cualquier producto que nuestros clientes puedan necesitar.

## Solutions

New solutions for every window type. We can design and manufacture in a record time all kind of system required by customers, thanks to our new manufacturing process.

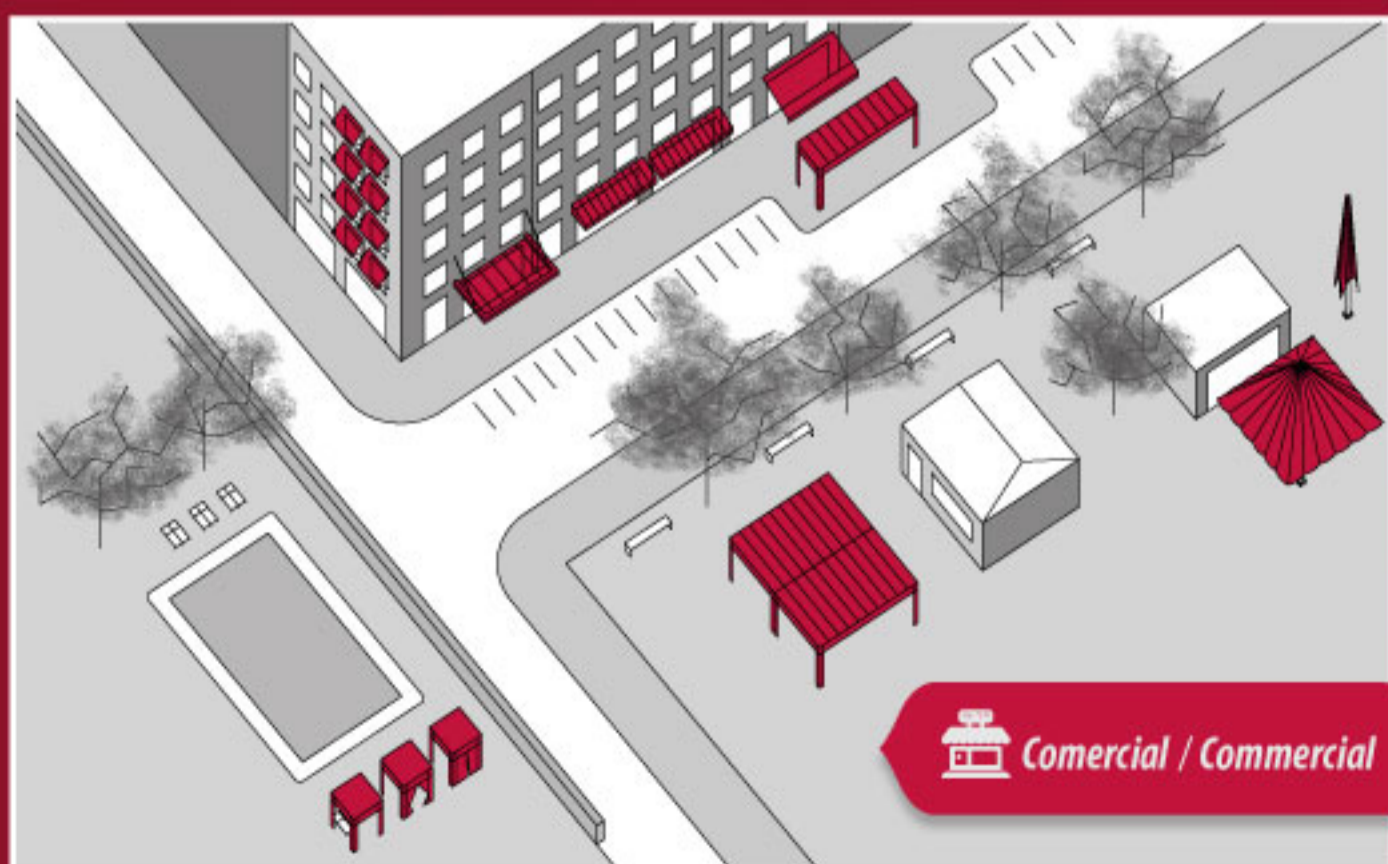
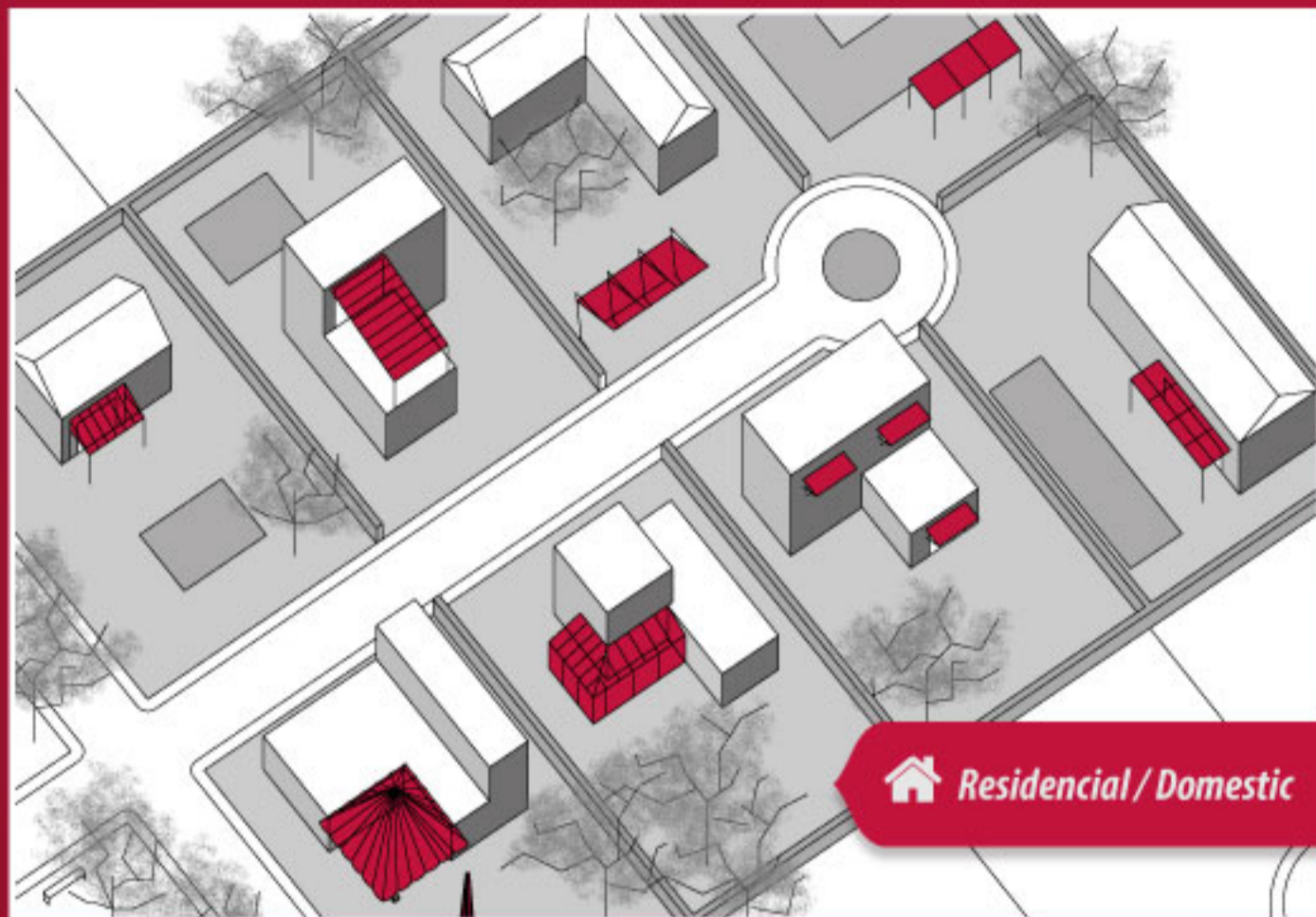



**Cubiertas Terrazas**  
Terrace Covers



**Terraza**  
Terraces



**Estacionamiento**  
Carport



**Pérgola Exenta**  
Free-Standing Canopy



**Cubierta Terraza**  
Terrace Cover

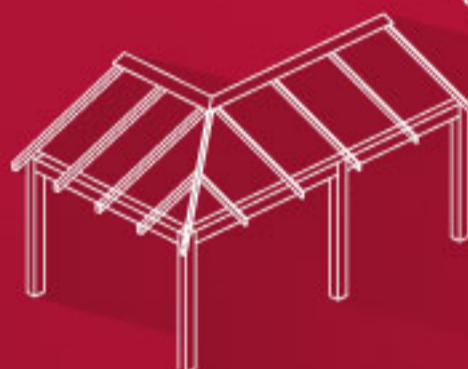

**Solución Esquina**  
Corner Solution



**Pérgola**  
Canopy



**Toldo Adosado**  
Connected Canopies

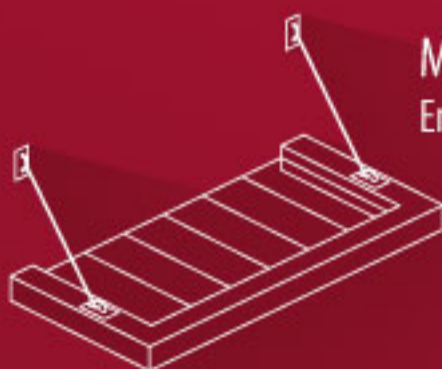

**Marquesina Entrada**  
Entrance Shelter



**Sombrilla**  
Umbrella

# Protección Solar / Sun protection

*Tu ambiente especial / Your own special atmosphere*

## nevaluz®

[www.nevaluz.com](http://www.nevaluz.com)

### Sevilla

Polig. Ind. Maza y Marín,  
nave 16. 41400 Écija (Sevilla)  
Tlf. 955 90 53 30 / 90  
Fax. 955 90 31 11

[info@nevaluz.com](mailto:info@nevaluz.com)



### Valencia

Travesía del Boverar, 70  
Pol. Ind. El Boverar.  
46970 Alaquàs (Valencia)  
Tlf. 902 808 251  
Fax. 902 808 252

[nevaluzvalencia@nevaluz.com](mailto:nevaluzvalencia@nevaluz.com)



### México

Avenida Araucarias lote  
28 manzana XVIII, entre  
Av. Las Torres y Araucarias  
en la Ciudad Industrial  
Bruno Pagliai en Tejería,  
Veracruz 91697 (México)  
Tlf. 01 (229) 981 18 80  
Fax: 01 (229) 981 18 86

[nevaluzmexico@nevaluz.com](mailto:nevaluzmexico@nevaluz.com)



### Perú

Centro Logístico Portada  
de Lurin, Almacén F-18.  
Autopista Panamericana Sur, km 38.  
Punta Hermosa, Lima (Perú)  
Tlf. 00 (511) 634 67 00  
Tlf. 00 (511) 634 67 01

[nevaluz@nevaluz.com.pe](mailto:nevaluz@nevaluz.com.pe)

